

MATRIX
CINEMA 3D

user manual

TABLE OF CONTENTS

Product Overview	1	Other Connection Options	7
Charging	2	Bluetooth Auracast	7
Powering On	2	MEEcast	7
Connecting via Bluetooth	3	Wired Audio (USB)	7
Media Controls	4	Troubleshooting	8
Phone Controls	4	Factory Reset	8
Bluetooth Multipoint	5	Disabling the Touch Control Panel	8
3D Sound (Spatial Audio)	5	Additional Support	8
CinemaEAR Audio Enhancement	5	Controls Quick Reference	9
Noise Canceling & Transparency	6		
Quick Conversation Mode	6		

PRODUCT OVERVIEW

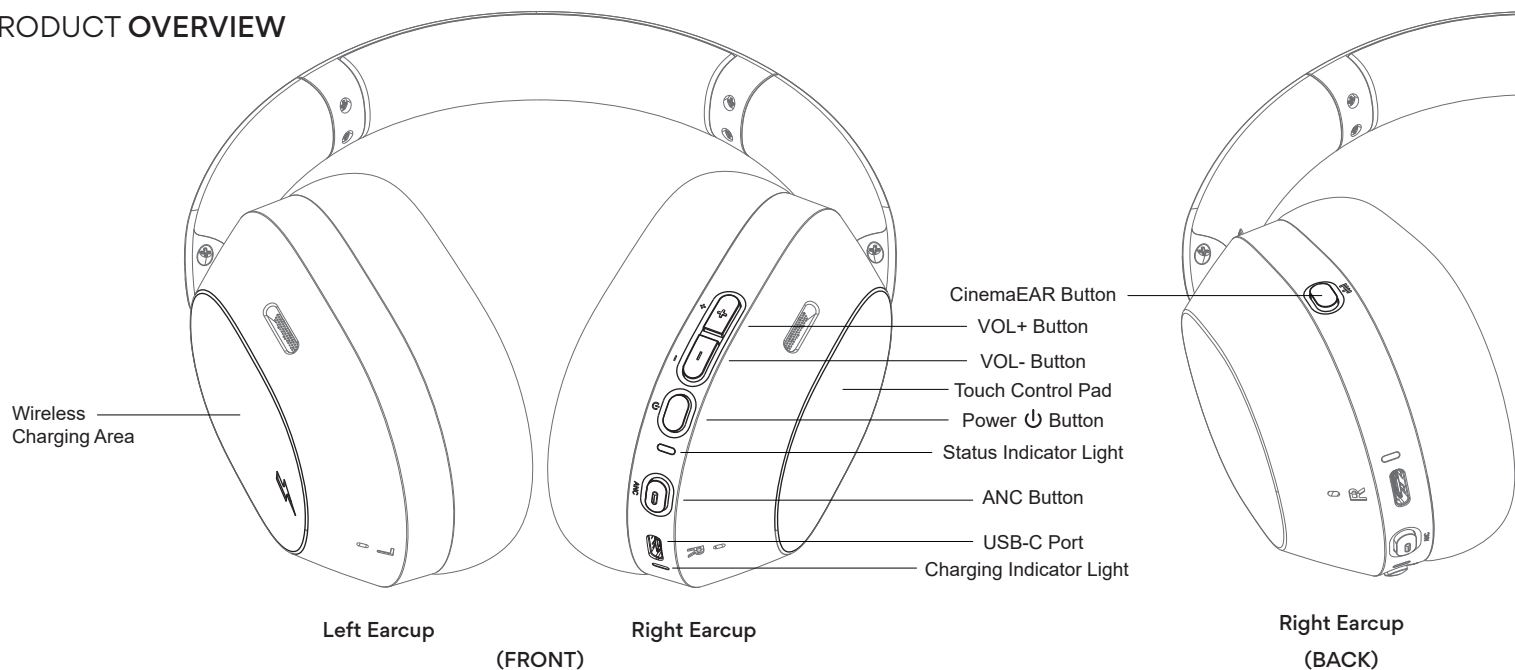

CHARGING

Charging can take up to 3 hours. The charging light will pulse green while the headphones are charging and turn solid green once fully charged.

USB-C Cable

Plug the included USB-C into any powered USB-C port and into the Cinema 3D headphones.

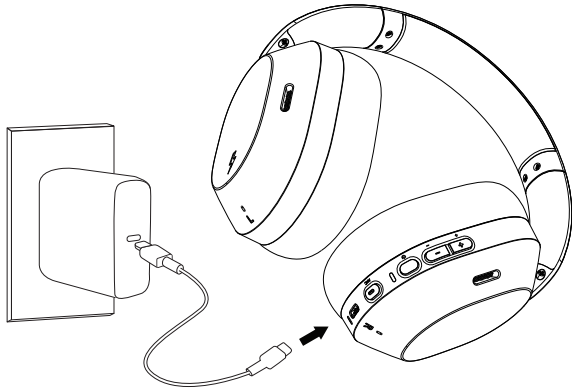

Charging Pad

Plug the included charging pad into any powered USB port such as the USB port on your TV. Place the charging pad against the left earcup of the Cinema 3D headphones to charge.

Note: the headphones automatically power off when the charging pad is attached and will power on when it is removed.

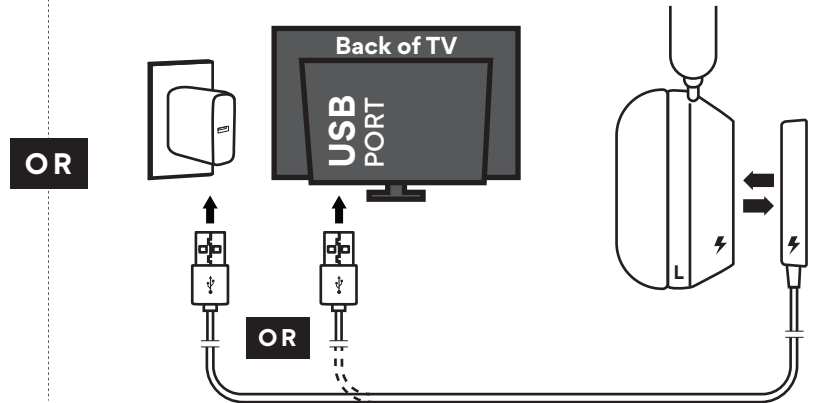

POWERING ON

Remove the charging pad OR press and hold the Power ⏻ button for 3 seconds.

Remove Charging Pad

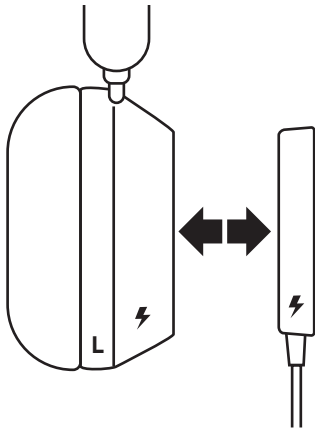

OR

Press & Hold 3s

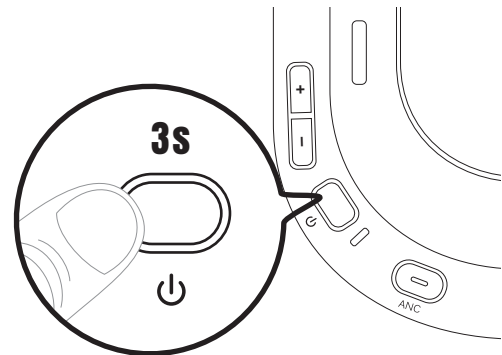

To power off, attach charging pad OR press and hold Power ⏻ button for 3 seconds.

CONNECTING VIA BLUETOOTH

Bluetooth pairing mode is indicated by alternating red and blue lights. The Cinema 3D enters pairing mode automatically the first time you use it.

Use the operation below to manually enter pairing mode if needed:

While Powered Off:

While Powered Off:

Press and Hold
Power  Button
for 7 seconds

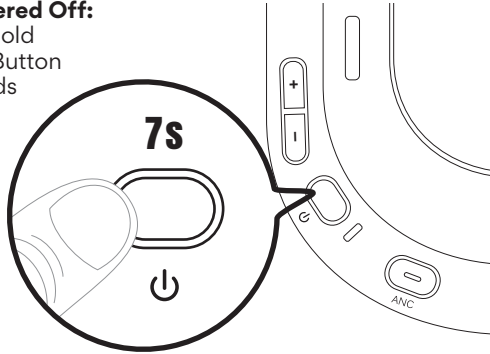

OR

While Powered On:

While Powered On:

Press and Hold
VOL+ and VOL- Buttons
for 3 seconds

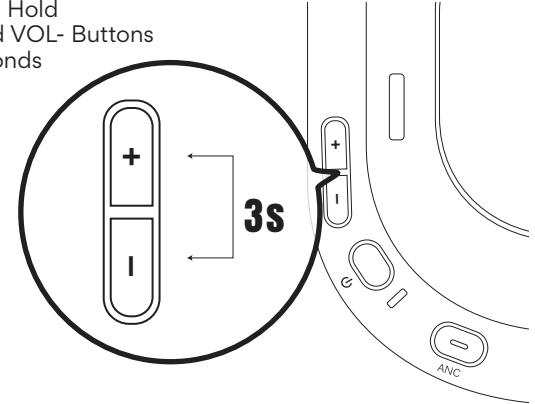

Once the Cinema 3D is in pairing mode, use the Bluetooth menu of your TV or other device to search for and select "MEE audio Cinema 3D".

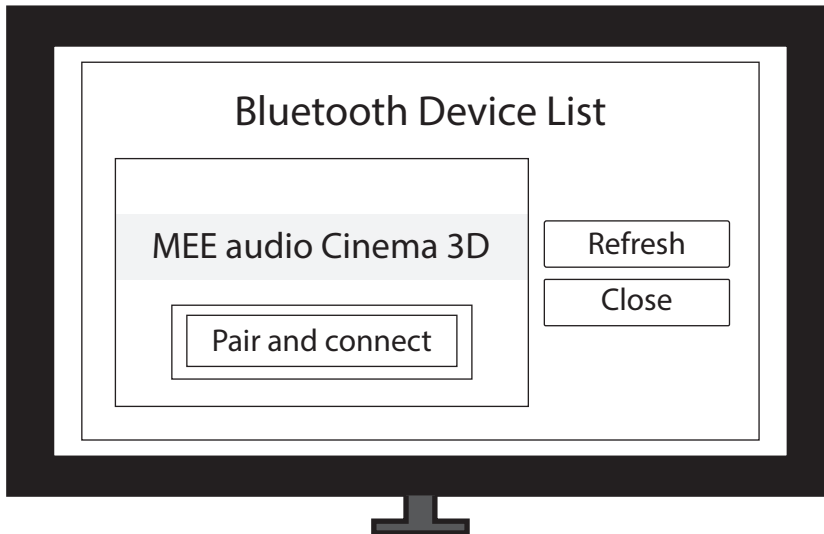

OR

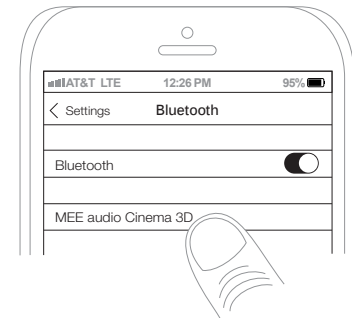

MEDIA CONTROLS

Increase Volume

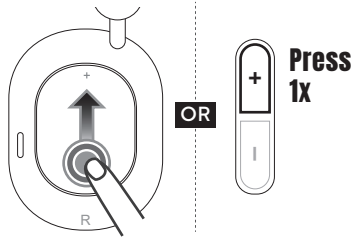

Swipe Up on Touch Panel OR
Press VOL+ Button 1x

Decrease Volume

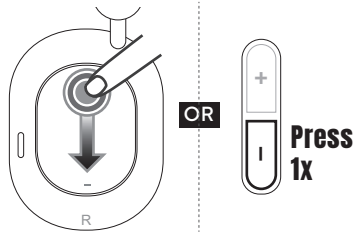

Swipe Down on Touch Panel OR
Press VOL- Button 1x

Next Track*

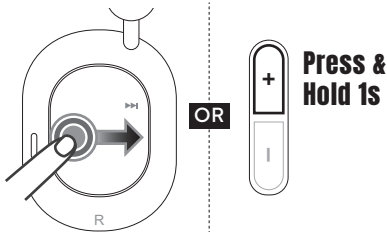

Swipe Forward on Touch Panel
OR Press and Hold VOL+ Button
for 1 second

Previous Track*

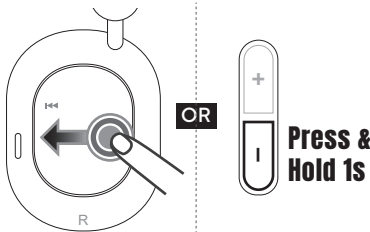

Swipe Backward on Touch Panel
OR Press and Hold VOL- Button
for 1 second

Play / Pause Media*

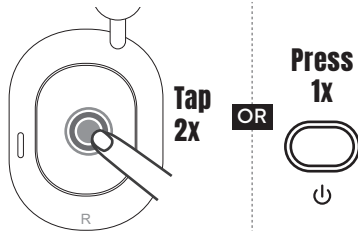

Tap 2x on Touch Panel OR
Press Power \downarrow Button 1x

PHONE CONTROLS*

Answer / Hang up Call

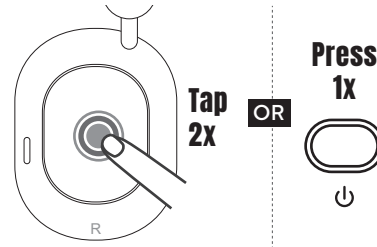

Tap 2x on Touch Panel OR
Press Power \downarrow Button 1x

Refuse Call



Press and Hold
Power \downarrow Button 2s

Mute / Unmute Call



Press and Hold
Touch Panel 2s

Siri® / Google Assistant™ / Voice Command

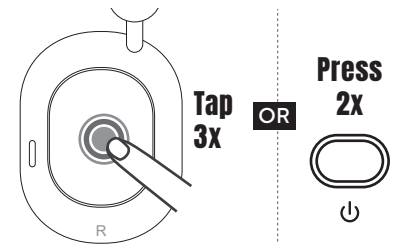

Tap 3x on Touch Panel OR
Press Power \downarrow Button 2x

*When connected to a Bluetooth device that supports this feature

BLUETOOTH MULTIPOINT

Bluetooth multipoint can be used to connect two Bluetooth devices to your Cinema 3D headphones simultaneously.

For example, your headphones can stay connected to both your TV and your phone so you can enjoy your favorite shows and not worry about missing important phone calls.



Enable / Disable Bluetooth Multipoint:

Press and Hold
Power  AND VOL+ Buttons
for 3 seconds

When multipoint is enabled, pair both of the devices you wish to use by following the instructions in the “**Connecting via Bluetooth**” step on **Page 3**, then restart the Cinema 3D while both are in range to connect in multipoint.

3D SOUND (SPATIAL AUDIO)

With 3D Sound enabled, sound moves naturally as you turn your head, increasing immersion and making it feel less like you’re wearing headphones.

To keep the effect realistic, the Cinema 3D automatically recenters the audio if you keep looking in one direction for a few seconds. You can also recenter manually at any time by facing your TV screen and tapping the touch panel once — this tells the headphones, “The screen is this way.”

Enable / Disable 3D Sound:

Press and Hold
the Touch Panel
for 2 seconds

Press and Hold
Power  AND
VOL- Buttons
for 3 seconds

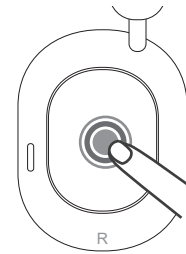

OR



Recenter 3D Sound:

Tap the Touch Panel 1x

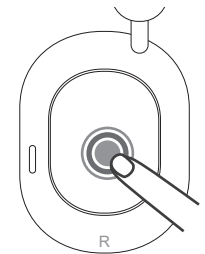

Tap
1x

CINEMAEAR AUDIO ENHANCEMENT

CinemaEAR lets you switch between sound profiles at the touch of a button, allowing you to tailor your listening experience to your media and personal preferences.



Clear Voice Mode boosts speech clarity to make dialogue in movies and TV shows easier to hear over background sounds.



Clear Voice Plus Mode offers an alternative enhancement that may provide greater speech clarity and intelligibility for certain listeners.



Music Mode enhances bass and treble for a more vibrant and engaging music experience.



Bass Boost Mode increases bass response and depth for more impact and immersion in both movies and music.

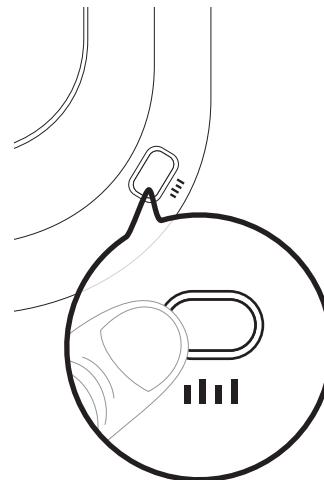

Enable CinemaEAR:

Press CinemaEAR button 1x

Cycle CinemaEAR Modes:



Press CinemaEAR button 1x

Disable CinemaEAR:

Press and hold CinemaEAR button for 3 seconds

NOISE CANCELING & TRANSPARENCY

Active Noise Canceling (ANC) technology gives you control over how much outside noise the Cinema 3D lets in:

-  **ANC Off** gives you natural sound without any noise filtering.
-  **ANC On** reduces background noise, helping you focus on your audio.
-  **Transparency** lets in ambient sound to help you maintain awareness of your surroundings.

Cycle ANC Modes:
Press ANC Button 1x

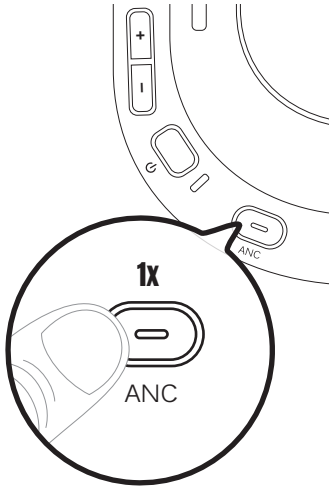

QUICK CONVERSATION MODE

Quick Conversation Mode temporarily mutes the audio and enables Transparency Mode, allowing you to have a conversation without pausing your media or removing your headphones.

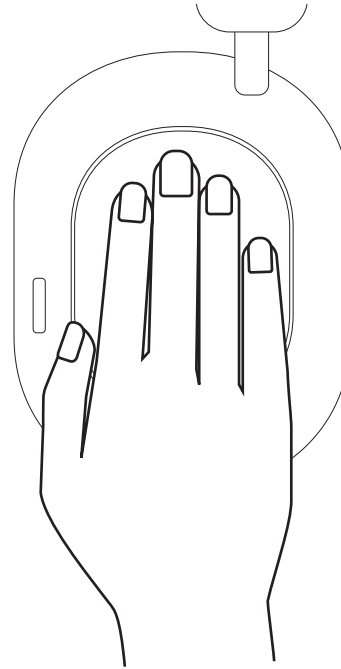

Quick Conversation Mode:
Cover Touch Panel
firmly with palm

 **WARNING** - avoid touching or hitting the external microphones while in ANC or Transparency mode as doing so may result in damage to the headphones and/or hearing discomfort.

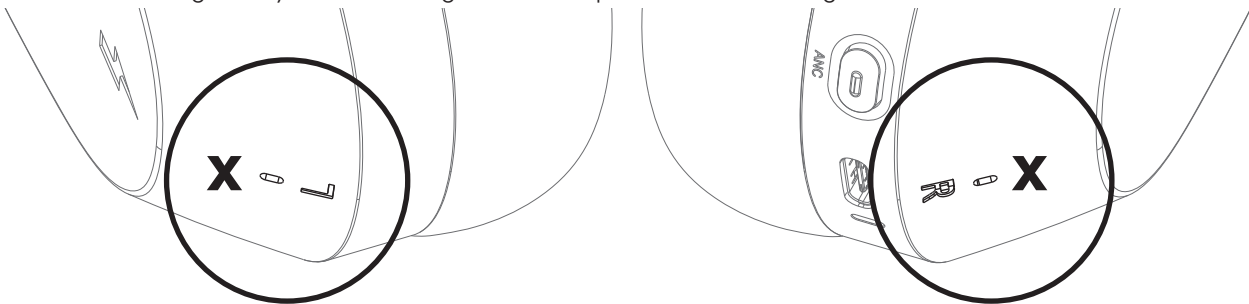

OTHER CONNECTION OPTIONS

Bluetooth Auracast

Auracast is a new Bluetooth feature that lets you tune in to shared audio broadcasts with your headphones by using your Auracast-compatible mobile device to locate and select the broadcast.

To use Auracast, first connect the Cinema 3D to your Auracast-compatible phone via Bluetooth, then use your phone's Auracast menu to find and join the broadcast.



Wired Audio (USB)

The Cinema 3D can be used in wired mode with any USB audio device such as a phone, laptop, or tablet. This can be useful when your Cinema 3D is out of battery, or if you need higher-quality or zero-latency audio, such as for gaming.

The Cinema 3D will enter USB audio mode automatically when plugged into your device with the included USB-C cable or another USB cable.

By default, the Cinema 3D will also charge when used via USB. Charging can be temporarily disabled to preserve the battery life of your device.



Disable / Enable USB-C Charging:

Press Power  Button 3x

MEEcast

MEEcast is a wireless broadcasting feature that does not require a smartphone, designed exclusively for use with MEE audio MEEcast-enabled transmitters. It is not compatible with standard Bluetooth or Bluetooth Auracast devices.

To use MEEcast, switch your Cinema 3D into MEEcast mode, then cycle through the available MEEcast channels until you hear the audio from your MEEcast transmitter.

Switch between MEEcast Mode and Regular Bluetooth / Auracast Mode:

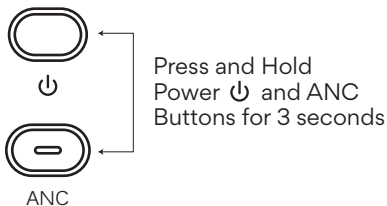

Next MEEcast Channel:

Swipe Forward on Touch Panel

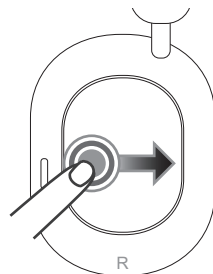

OR

Press and Hold VOL+ Button for 1 second

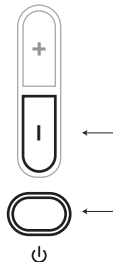

Previous MEEcast Channel:

Swipe Backward on Touch Panel

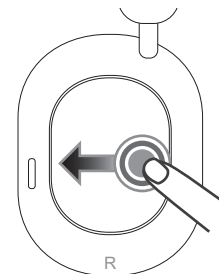

OR

Press and Hold VOL- Button for 1 second

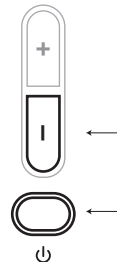

Note: refer to the “Controls Quick Reference” table on Page 9 for a list of features/controls available with each connection option.

TROUBLESHOOTING

Factory Reset

Most issues can be solved by resetting the Cinema 3D and re-connecting it to your device.



Note: Resetting will restore all settings to their original factory defaults and erase all previous Bluetooth pairings. You'll need to delete the Cinema 3D from your Bluetooth device list and create a new pairing before using the headphones again.

Touch Panel

The touch panel controls on the Cinema 3D can be disabled for users who prefer to only use the tactile buttons.

Disable/Enable Touch Panel Controls:
Press and Hold ANC Button for 5 seconds

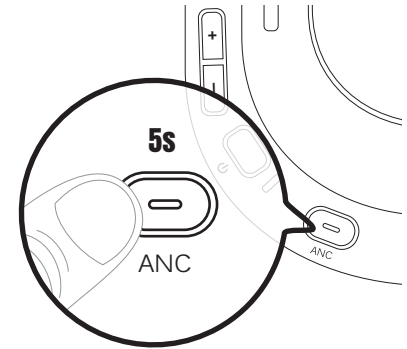

Note: with the touch panel disabled, the control to manually recenter 3D Sound (Spatial Audio) will be unavailable. 3D Audio will still recenter automatically after a few seconds.

FOR ADDITIONAL SUPPORT

For Safety Warnings, Care Instructions, and Warranty Information, refer to the Quickstart Guide included with your headphones.

Visit our Cinema 3D support guide for latest troubleshooting information at MEEaudio.com/Cinema3Dsupport



Video Guide

View our video setup guide at MEEaudio.com/Cinema3Dvid or by scanning the QR code

Questions? We're Here to Help!

Phone Support: 626-965-1008
Monday ~ Friday 9:00am to 5:00pm PST

Email Support: support@meeaudio.com
All emails are responded to within 2 business days

MEE audio and its logo are registered trademarks of S2E, Inc. All rights reserved.

The Bluetooth® word mark and logos are registered trademarks owned by Bluetooth SIG, Inc. and any use of such marks by MEE audio is under license. Other trademarks and trade names are those of their respective owners. The Auracast™ word mark and logos are trademarks owned by the Bluetooth SIG, Inc. Any use of such marks by MEE audio is under license. Other trademarks and trade names are those of their respective owners.

LDAC and LDAC logo are trademarks of Sony Corporation.
Siri is a registered trademark of Apple Inc.
Google Assistant™ is a trademark of Google Inc.

CONTROLS QUICK REFERENCE

	Function	Button Control	Alternate Control	Supported Mode(s)			
				Bluetooth Mode	Bluetooth Auracast	MEEcast	Wired (USB-C)
Media and Phone calls	Power on	Press and hold power button 1s	Remove charging pad	✓	✓	✓	✓
	Power off	Press and hold power button 2s	Attach charging pad	✓	✓	✓	✓
	Pairing mode	Press and hold vol+ and vol- buttons 3s		✓			
	Increase volume	Press vol+ button	Swipe up on touch panel	✓	✓	✓	✓
	Decrease volume	Press vol- button	Swipe down on touch panel	✓	✓	✓	✓
	Play / Pause / Answer / Hang up call	Press power button	Tap touch panel 2x	✓			✓
	Next track	Press and hold vol+ button for 1s	Swipe forward on touch panel	✓			✓
	Previous track	Press and hold vol- button for 1s	Swipe backward on touch panel	✓			✓
	Refuse call	Press power button 2s		✓			
	Mute / unmute call		Press and hold touch panel 2s	✓			✓
	Siri / Google Assistant / AI / Voice Control	Press power button 2x	Tap touch panel 3x	✓			
	Enable / disable Multipoint	Press and hold power & vol+ buttons 3s		✓			
3D Sound (Spatial Audio)	Enable / disable Spatial Audio	Press and hold power & vol- 3s	Press and hold touch panel 2s	✓	✓	✓	✓
	Recenter Spatial Audio		Tap touch panel	✓	✓	✓	✓
Active Noise Canceling	Cycle ANC modes	Press ANC button		✓	✓	✓	✓
	Quick conversation mode		Cover touch panel firmly with palm	✓	✓	✓	✓
CinemaEAR Audio Enhancement	Enable CinemaEAR	Press CinemaEAR button		✓	✓	✓	✓
	Cycle CinemaEAR modes	Press CinemaEAR button		✓	✓	✓	✓
	Disable CinemaEAR	Press and hold CinemaEAR button 3s		✓	✓	✓	✓
MEEcast	Switch to MEEcast mode	Press and hold ANC & power buttons 3s		✓	✓		
	Cycle MEEcast channels	Press and hold vol+ or vol- buttons 1s	Swipe forward or backward on touch panel			✓	
	Switch to Bluetooth mode	Press and hold ANC & power buttons 3s				✓	
Other	Disable / re-enable USB-C charging	Press power button 3x					✓
	Disable / re-enable touch panel	Press and hold ANC button 5s		✓	✓	✓	✓
Troubleshooting	Factory reset / clear memory	Press and hold power & CinemaEAR buttons 3s		✓	✓	✓	✓

