

CapTel® 2400i

With Speakerphone



Important Note

As you set up your new CapTel phone, be sure to follow the directions on the display screen for registering your phone. Per Federal Communications Commission (FCC) regulations, the Captions feature cannot be activated until your phone is registered.

This requirement is part of the FCC's effort to ensure the captioning service is used as intended by people who truly need the service.

FEDERAL LAW PROHIBITS ANYONE BUT REGISTERED USERS WITH HEARING LOSS FROM USING INTERNET PROTOCOL (IP) CAPTIONED TELEPHONES WITH THE CAPTIONS TURNED ON. Advanced speech recognition software is used to process calls, and, in certain circumstances, a live communications assistant may be included on the call. There is a cost for each minute of captions generated, paid from a federally administered fund. No cost is passed on the CapTel user for using the service.

For more information about FCC requirements, please visit www.CapTel.com

About Your New CapTel 2400i

Your new CapTel 2400i is like any other telephone in many ways: it connects to a telephone line, you talk and listen to your callers, and you place/answer calls the same way you use any other telephone.

Your new CapTel phone is also different than a traditional telephone in some important ways.

In order to show captions, your CapTel phone connects to the Internet the same way you connect a computer to the Internet. The Internet connection links to a Captioning Service, which uses advanced speech recognition technology to transcribe everything your caller says into captions, either automatically or with the help of a specially-trained communications assistant. The captions are sent back over the Internet connection to your CapTel phone, for you to read on the display screen.

Because the CapTel 2400i relies on the Internet to provide captions, setting up the phone takes a few extra steps to make sure it is connected to the Internet properly.

Where to Get Help

Help is available 24 hours a day, 7 days a week (excluding major holidays).
Please contact:

Toll-Free Installation Help Line: 888-269-7477
Email: CapTel@CapTel.com • Fax: (608) 238-3008
Online Help: www.captel.com/customer-service

If someone else installed your home computer or your Internet connection, you may want to consult with that person as you set up your CapTel phone.

Important Information when Calling for Help

The following information may help CapTel Customer Service troubleshoot your problem. If possible, please have this information handy when you call for help:

My Telephone Number

My CapTel 2400i Electronic Serial Number (ESN)
(located underneath your CapTel phone)

My Internet Service Provider

My Telephone Service Provider

If using WiFi: Name of your WiFi Network

WiFi Password (also sometimes called "Pass Phrase" or "Network Key")

T A B L E O F C O N T E N T S

What is in the Box?	3
Overview of CapTel 2400i	4
Setting up Your CapTel 2400i	7
Requirements	7
Step 1: Select a location.....	7
Step 2: Plug in the power adapter	8
Step 3: Select language	8
Step 4: Network Connection.....	9
Step 5: Time and Date	13
Step 6: Software.....	14
Step 7: Telephone Line.....	15
Registration Terms and Conditions	16
Choosing Your Captioning Preference	23

What is in the Box?

Your CapTel 2400i includes the following parts:



- CapTel 2400i Phone
- Telephone Cord



- Power Adapter – to plug into a wall outlet



Important! Use only the power adapter that came in the box with your CapTel 2400i

- Ethernet Cable – to connect to Internet service (not necessary for WiFi installations)



- CapTel Setup Guide and CapTel User Manual



Overview of CapTel 2400i Phone



Please see the descriptions that correspond with the matching numbers to help explain what each feature is.



1 Touch Screen Display

Shows captions, Caller ID, Answering Machine messages, Contacts, and more. To select an item, touch it on the display.



2 Volume Button

Lets you adjust the volume to a comfortable level, up to a 40dB gain from min/max. To increase the volume, press **+** on the VOL button. Press **-** on the VOL button to decrease the volume. The indicator lights next to the volume bar show the volume setting. The volume returns to a mid-range setting every time you hang up the handset.

WARNING

The maximum volume setting is extremely loud. People who do not need amplification should not use the phone at the highest volume level.

- ## 3 Built-in Microphone

Speak near to the microphone when using the speakerphone.



4 HOME Button

Press the HOME button at any time to return to the main menu screen. If you are ever “lost” in the menu system, press the HOME button to return to the main screen.



5 CAPTIONS Button

When the CAPTIONS button is on (blue light around button is lit) you will see captions of everything the other party says. Press the CAPTIONS button at any time during a call to turn captions on or off.



6 CUSTOMER SERVICE Button

Press the CUSTOMER SERVICE button to automatically dial the CapTel help line. Our helpful Customer Service team is happy to help you set up and use your CapTel phone – we’re only a button push away.

NOTE

Help is available 24 hours a day, 7 days a week (closed on major holidays). Help materials are also available online at www.CapTel.com

Back view of CapTel 2400i



1 Telephone Jack

Plug the telephone cord (provided) in here (RJ11 jack). Telephone cord can be for most types of telephone service, including: analog, VOIP, fiber optic, digital cable service, or analog with DSL service. CapTel does NOT work with PBX systems unless an analog port is available.

2 LNK/ACT – Status Light

Lets you know if your Ethernet cable is connected to the Internet and whether activity is on the line. NOTE: the LNK/ACT indicator does not light up when connected via WiFi.

3 Ethernet Jack

Plug the Ethernet cable (provided) here to connect to your Internet service. If you connect to the Internet using a WiFi network, you do not need to plug in the Ethernet cable.

4 Power Jack

Plug the AC power adapter here. Use only the AC power adapter that came with your CapTel 2400i phone. Any other adapter may damage the phone.

5 Kickstand

Pull out and position the kickstand to find the most convenient angle for reading the CapTel display screen.

Setting up Your CapTel 2400i

Requirements

- 1. High-speed Internet access.** Your CapTel phone can connect to your Internet service either with an Ethernet cable or through a wireless (WiFi) network. Depending on your Internet setup, a router may also be required to allow you to connect more than one device to your Internet service.
- 2. Telephone Service.** Can be analog line, DSL with filter, VOIP, fiber optic, or Digital Cable phone service. CapTel does NOT work with digital Private Branch Exchange (PBX) systems found in some office environments, residential facilities, and hotels – unless an analog port is available.

NOTE

If you do not have dial-tone telephone service, contact Customer Service for installation assistance with Internet-only option.

- 3. Standard electrical power** (AC adapter plugs into standard wall outlet).

Step 1: Select a Location

Pull out the kickstand in the back, then set up the CapTel phone in a place where:

- A high-speed Internet (Ethernet) jack or your wireless router is located nearby.
- A telephone jack is located nearby (can be analog line, DSL with filter, VOIP, fiber optic, or Digital Cable phone service).
- There is an electrical outlet nearby.
- The surface it will be set on is stable and secure.
- The area is protected from excessive heat or humidity.

NOTE

The outlets for power, the phone line, and the Ethernet connection should all be located nearby, as each cord needs to plug into your CapTel phone. If your Internet access is located in a different room than where you plan to use the CapTel phone, a WiFi setup is recommended.

Step 2: Plug in the Power Adapter

1. Plug the power cord into the jack labeled "Power" on the back of the CapTel phone.
2. Plug the power adapter into a wall outlet or power strip. The display screen and Volume indicator lights will light up to let you know the power is connected.

WARNING:

Be sure to use only the power adapter that came with your CapTel 2400i. Using any other power adapter may damage your phone.

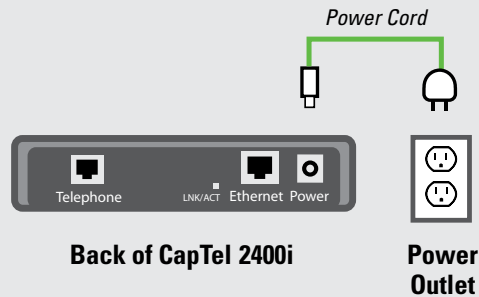



After a moment, the Initial Setup screen will appear. Follow the instructions on the display screen.

TIP To choose an option, touch the icon on the screen and then touch  (**next**).

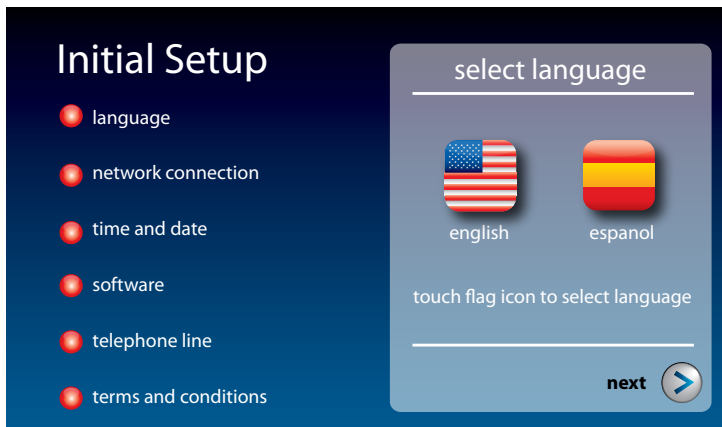
Step 3: Select Language



1. Touch  (**English**) or  (**Espanol**) for the language you want.
2. Touch  (**next**) to continue.

Step 4: Network Connection

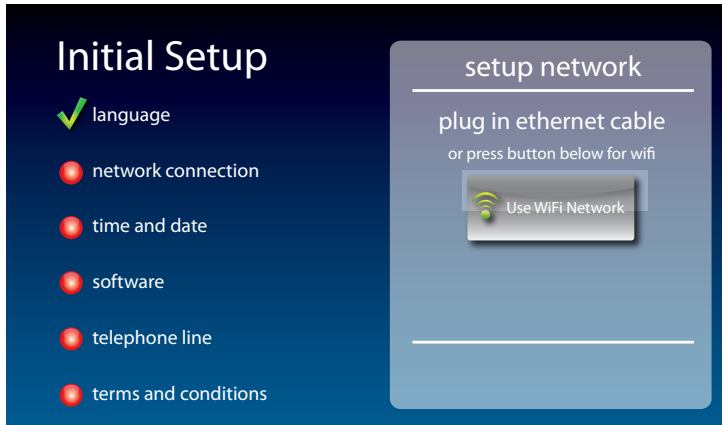

For Wired Connections:

1. Plug the Ethernet cable that came with your phone into the jack on the back of the CapTel phone labeled "Ethernet".
2. Plug the other end of the Ethernet cable into the jack you use to access your Internet service. Depending on how your Internet service is set up, you could be plugging into an available Ethernet jack on any of the following:
 - On a digital cable modem
 - On a DSL modem
 - On a router in your home
 - In an Ethernet wall outlet

Use the examples on the following page to match your setting with the correct installation method.

All outlets located together (Wired Setup)

Example 1: All of the connection outlets (telephone, Internet, and power) are available in the same room that you are planning to use the CapTel 2400i.

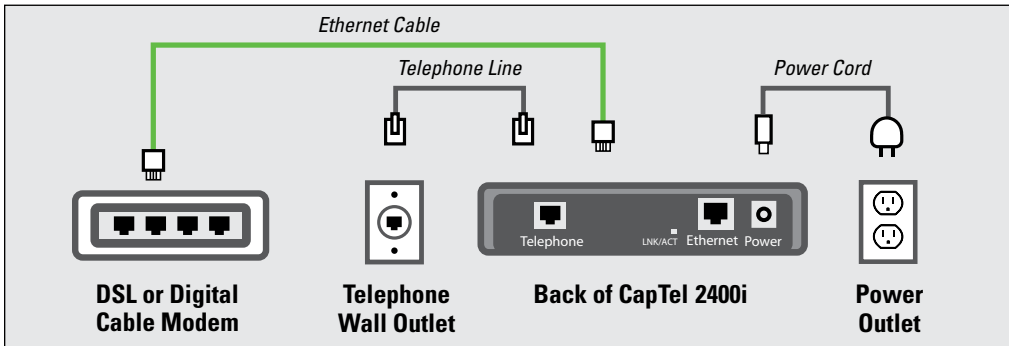

Example 2: If there is not an available Ethernet jack in your DSL or cable modem, you will need a router or switch that lets you connect more than one device to the Internet. Contact your Internet Service Provider to learn what router or switch will work with your modem. The router should support DHCP. Connect the router to your DSL/cable modem. Then connect the CapTel 2400i to the router or switch using the Ethernet cable.

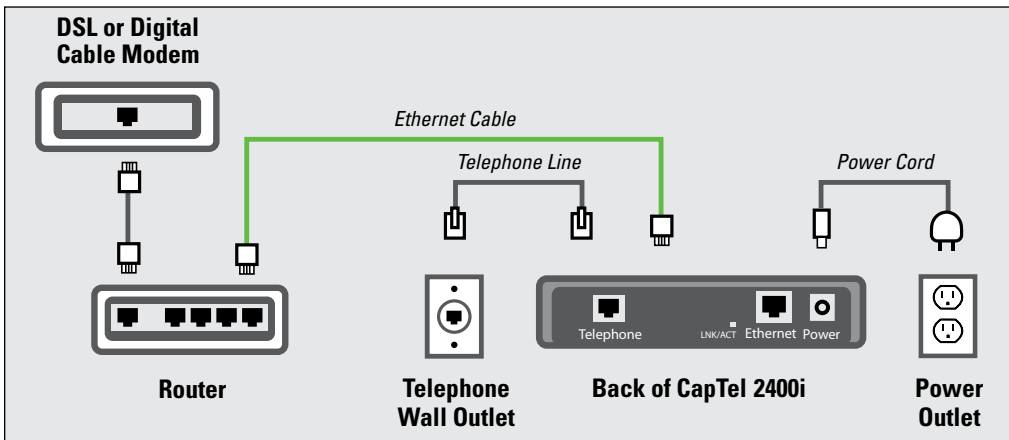

For Wireless (WiFi) Connections:

If you have a wireless (WiFi) network in your home or office, your CapTel phone can connect to the Internet using the WiFi network. You do not need to plug in an Ethernet cable.

To set up your CapTel for WiFi use, you will need to know the name of your wireless network as well as any passwords that are needed to access the network. The way you access your WiFi network with CapTel will be very similar to how you access the network from a computer or mobile device.

NOTE

If someone helped install the wireless network for you, it may be helpful to consult with that person as you set up your CapTel phone.

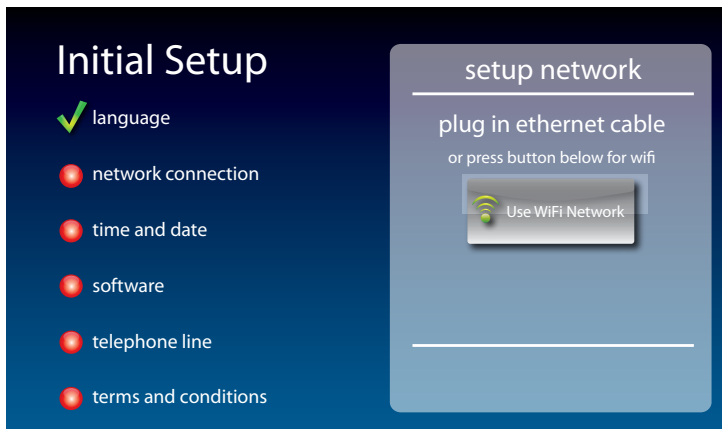

1. Touch  **(Use WiFi Network)** on the display screen. CapTel scans for wireless networks within range of your phone.
2. The display lists any WiFi networks detected, in order of strongest signal strength to the weakest signal strength.

NOTE

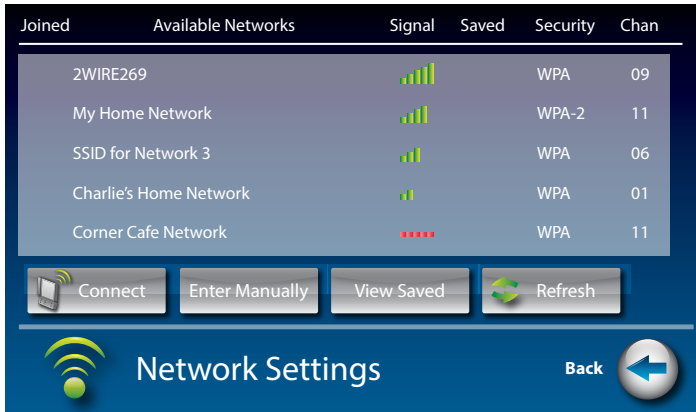

CapTel may detect wireless networks in your location that you do not recognize – such as a wireless network from a neighbor or nearby office. Be sure to select the name that matches your own network.



3. Touch the name of the network that you want to use.

Then touch  **(Connect)**.

If you do not see the network you want to use:

- Try moving your CapTel phone to an area closer to your wireless router. Then, touch  **(Refresh)**. CapTel will re-scan for available networks.
- Touch  **(Enter Manually)**. CapTel will ask you to enter information about your wireless network, then it will try to connect.

4. **Enter WiFi Password:** On the display, use the onscreen keyboard to enter the password for your WiFi network.

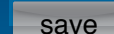

TIP

Remember to use the  **(shift)** key for capital letters when needed. Passwords are case-sensitive. To enter special characters, touch  **(Numbers)**.

When you are done, review your password carefully. If it does not exactly match the password for your network, CapTel will not be able to connect. Use the  key to correct any errors.

When you are satisfied the password is correct, touch  **(save)**.

Step 5: Time and Date

Touch the Time Zone on the display screen that you live in. Be sure to indicate if your Time Zone practices Daylight Savings Time (DTS). Touch  **(next)** to continue.

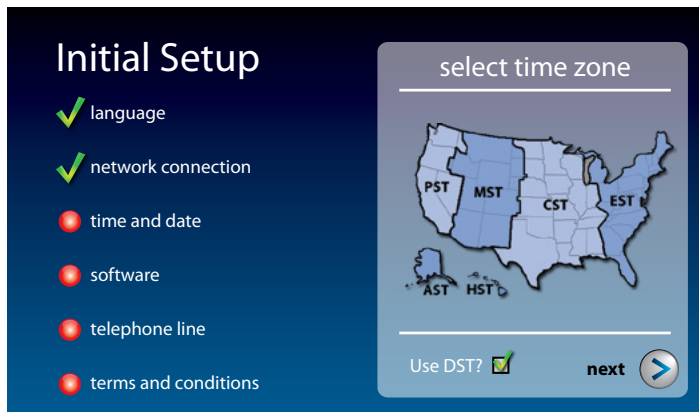

Your CapTel phone will fill in the date and time based on the time zone you indicate.

Step 6: Software

Your new phone checks to make sure that you have the most current software available. If needed, CapTel will automatically download the most recent software version. Please be patient, the download may take a few moments. Watch the progress on the CapTel display screen to know the status.

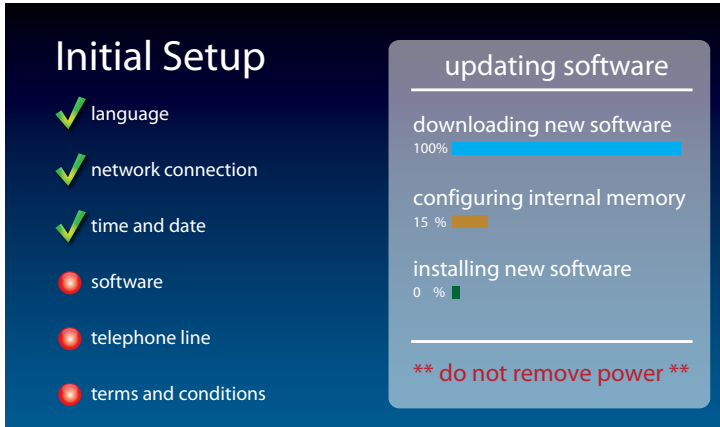

NOTE Do not interrupt the power supply during a software installation. It may damage your CapTel phone.

Once the software download is complete, your CapTel phone will re-boot as part of the update process. It will automatically run through the setup steps again.

Once the update process is completed, you will be able to continue with setup.

Step 7: Telephone Line

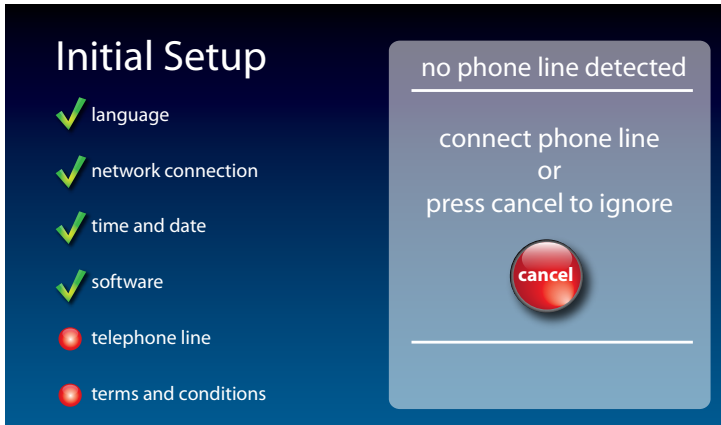

1. Plug your telephone line into the back of the CapTel phone.
2. Plug the other end of the line into your telephone wall jack.

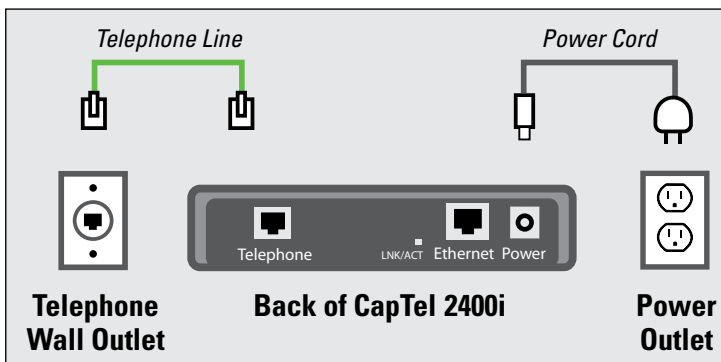

NOTE

Telephone service can be analog, VOIP, fiber optic, digital cable phone service, or analog with DSL filter. CapTel does not work with digital PBX office phone systems unless an analog port is available.

NOTE

If you do not have dial-tone telephone service, contact Customer Service for installation assistance with Internet-only option.

Registration Terms and Conditions

The very first time you set up CapTel, you may be asked to review and accept the Registration Terms and Conditions on the CapTel display screen. The Terms and Conditions are set by the Federal Communications Commission (FCC) which oversees the funding for IP-based Captioned Telephone service.

If your phone display shows different instructions than the directions listed below, please follow the instructions on your phone's display screen.

NOTE

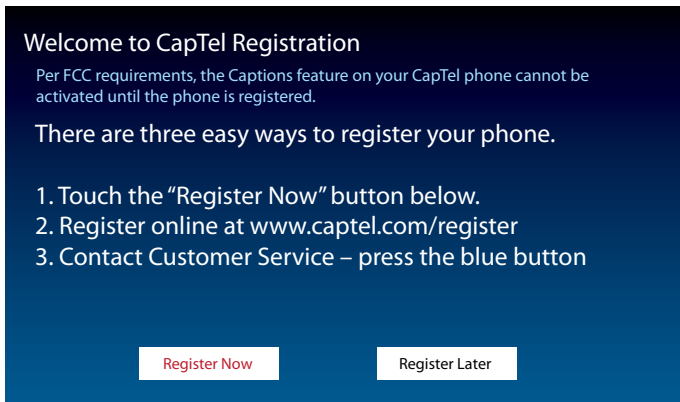

Per FCC requirements, the Captions feature on your phone cannot be activated until you accept the Registration Terms and Conditions. If you need assistance, press the blue **CUSTOMER SERVICE** button for help. Details about the FCC requirements can be found at www.CapTel.com



1. Touch **Register Now** (**Register Now**) to begin.



2. On the display, touch the field for first name.

3. Use the onscreen keyboard to enter your first name. Use  (**shift**) to enter capital letters.
4. Touch the field for last name, then enter your last name using the onscreen keyboard.
5. Continue until all fields are entered.
6. When you are finished, review the display to make sure you have everything entered correctly.
7. When you are ready, touch  (**save**).

NOTE

Per FCC requirements, registration information must be about the person who uses CapTel. If someone sets the CapTel phone up on your behalf, please make sure they use your contact information and not their own.

8. The display asks you to enter your birth date and the last four digits of your social security number.

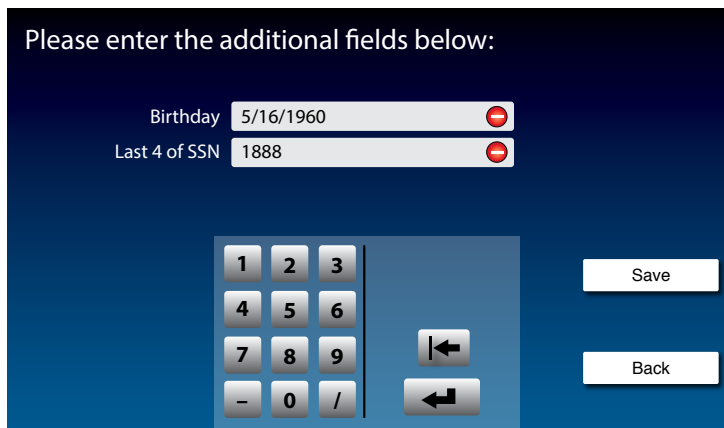

Please enter the additional fields below:

Birthday

Last 4 of SSN

1 2 3
4 5 6
7 8 9
- 0 /

Save

Back

NOTE

Why does FCC require this information? The FCC works to protect the captioning service from potential misuse by people who may not need captioning assistance. Your personal registration information confirms that you are a registered individual. All information provided is treated, by law, as confidential.

The display asks you to confirm your registration contact information.

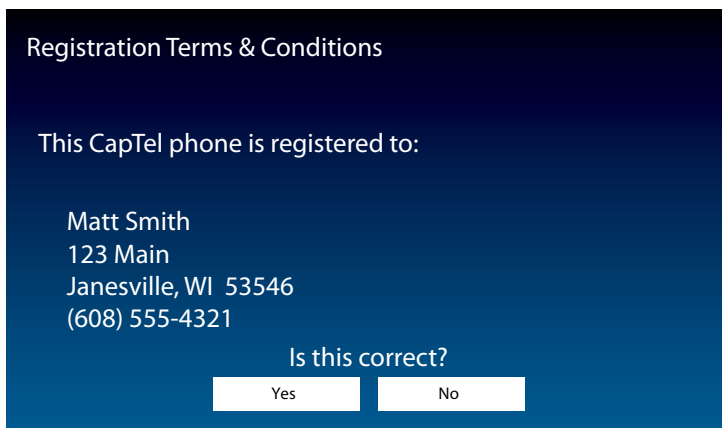

9. Check that the name and address listed on the display is correct.

If correct, touch (**Yes**) on the display.

If it is incorrect, touch (**No**). The display lets you re-enter your contact information and make corrections as needed. When it is correct, touch (**save**).

Next, the display asks you to confirm that you have a hearing loss that makes it difficult for you to hear over the phone so you need the captioning service.

The FCC wants to verify that anyone who uses the free Captioning Service really has hearing loss. It is the FCC's way of protecting the service from misuse by people who do not need captions.

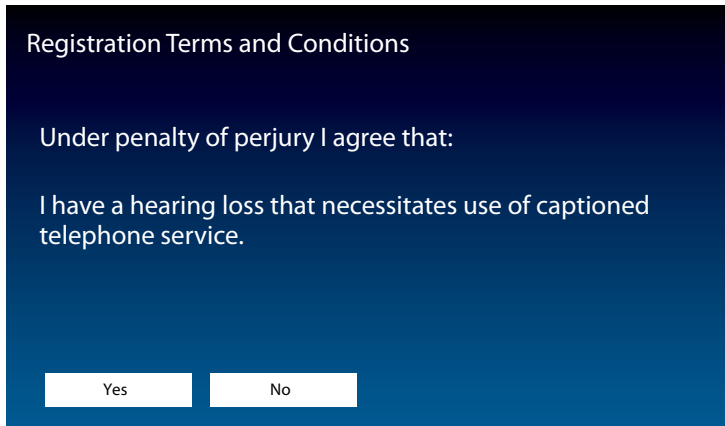

10. If you agree with the statement, touch **(Yes)**.
If you disagree, touch **(No)**.

While you can set your phone to use Auto Captions (fully automated, no operator involved), the screen checks to make sure you understand that, in some cases, a live communications assistant may help provide captions. You can indicate your Captioning Preference later in the setup process.

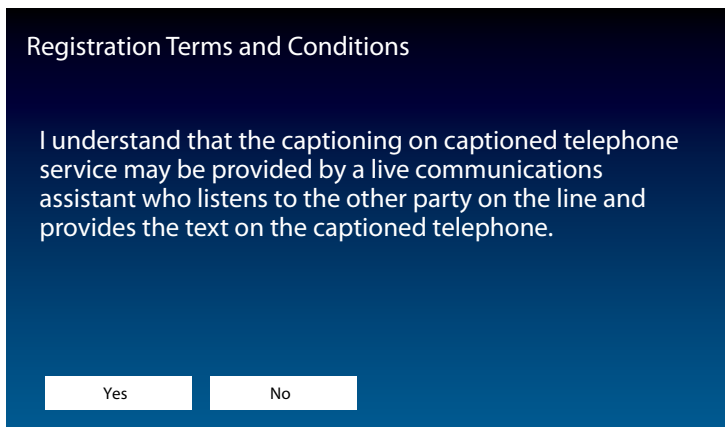

11. If you agree with the statement, touch **(Yes)**.

CapTel users do not have to pay for the cost of using the captioning service, it is provided at no cost to people with hearing loss through a fund monitored by the FCC. The FCC wants to make sure that CapTel users understand that – even though there is no cost to you – the federal program pays a per-minute cost for use of the service.

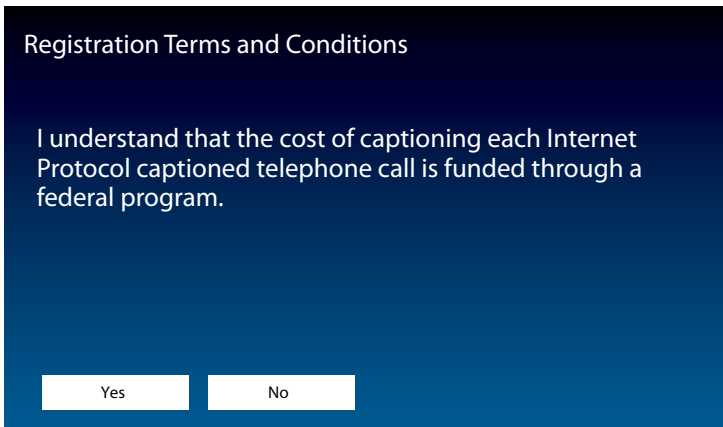

12. If you agree with the statement, touch **(Yes).**

Per FCC regulations, only people who are registered may use the CapTel phone when the captions feature is turned on. Others may use your phone as long as the CAPTIONS button is turned off. The display asks that you don't allow people who are not registered to use your CapTel phone when the captions feature is on.

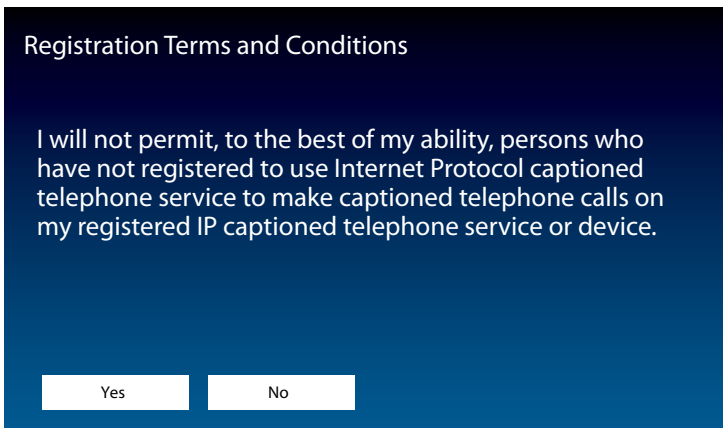

13. If you agree with the statement, touch **(Yes).**

The FCC requires that certain information be shared with the TRS User Registration Database to ensure that only registered users are accessing the captioning service. This is a security measure by the FCC. Your consent is required to share the information. For details about this requirement, visit online at www.CapTel.com/consent.

Registration Consent:

The Federal Communications Commission (FCC) requires that your name, address, telephone number, date of birth, and last 4 digits of your Social Security Number (or equivalent) be transmitted to the Telecommunication Relay Service (TRS) User Registration Database to assist with the administration of the TRS program. Failure to provide consent will result in denial of service.

I Consent

For more information on why the FCC requires us to collect this information, visit online: CapTel.com/consent

12. If you agree with the statement, touch (**I Consent**).

Congratulations! Your phone is registered and the Captions feature is enabled.

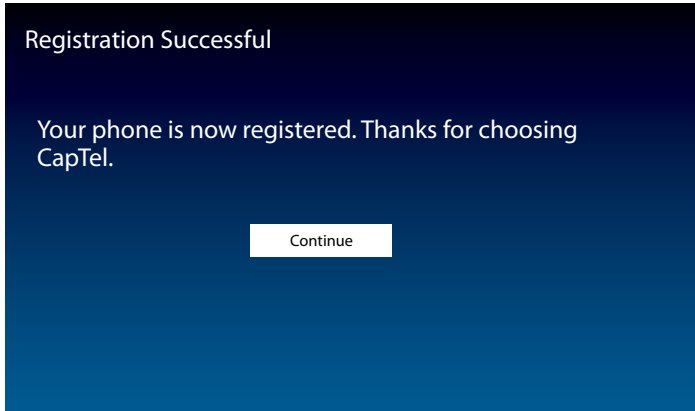

If you answered **NO** to any of the Registration Terms and Conditions, the Captions feature will not be activated on your phone. You will still be able to make and receive calls, but the calls will not be captioned.

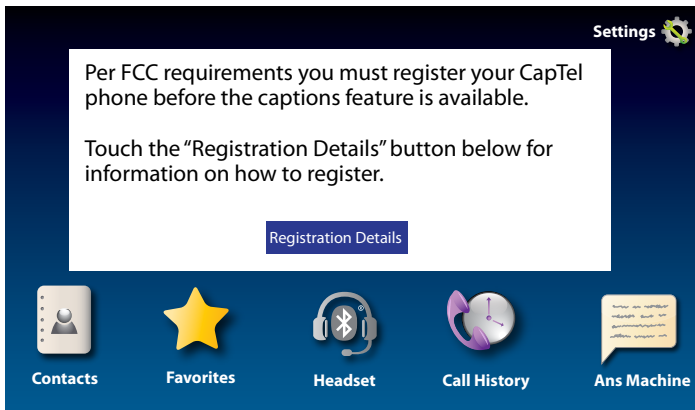

To review the Terms and Conditions again, press  (**CAPTIONS button**). If you have any questions, please contact CapTel Customer Service for assistance.

NOTE *Although the Captions feature is not enabled until you accept the Registration Terms and Conditions, you will be able to see captions when you call Customer Service so that we may assist you over the phone.*

Choosing Your Captioning Preference

Your CapTel phone lets you select which captioning method to use, either fully-automated Auto Captions or enhanced Assisted Captions.

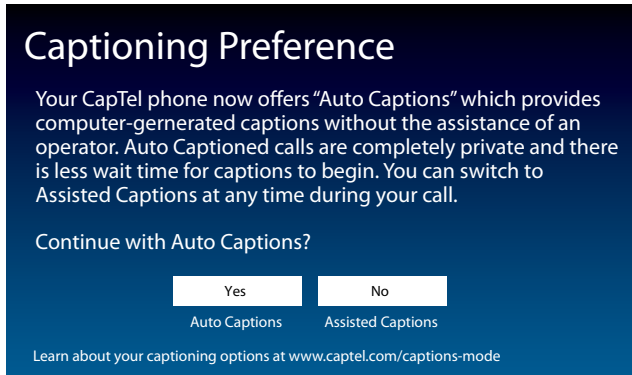

With **Auto-Captions**: Calls are entirely computer-generated.

- No operator on the call.
- Calls start almost immediately, no need to wait for an operator.
- Captions appear in real-time with no delays.

With **Assisted Captions**: An operator facilitates captioning, making corrections and providing call details.

- Operator makes corrections if needed.
- Captions include call details, such as background sounds, whether the speaker has (F) or (M) voice, music on hold, and the “beep” when you leave a voicemail message.
- If the line connection is poor or if there is static on the line, switching to Assisted Captions may improve accuracy.

Touch YES to use Auto Captions, or touch NO to use Assisted Captions.

Calls will start in whichever method you select. However, during a call, you can easily switch captioning methods—from Auto Captions to Assisted Captions—by following the onscreen instructions.

NOTE

911 Calls are given priority and will be processed using Assisted Captions once an operator is available. CapTel may adjust the captioning method of any call under certain circumstances, to provide the best possible captioning experience.

CapTel is the latest innovation from  **Ultratec**.

Ultratec, Inc.

450 Science Drive

Madison, WI 53711

(888) 269-7477 V/TTY

(866) 670-9134 (Spanish CapTel Customer Service)

Email: CapTel@CapTel.com • Fax: (608) 238-3008 • Online: www.CapTel.com

©2013-2023 Ultratec, Inc. All rights reserved.



Other trademarks and trade names are those of their respective owners.

This Setup Guide

This guide provides directions for quickly setting up your new CapTel 2400i captioned telephone to be ready to make and answer calls. For complete instructions about using your new phone, please see the CapTel 2400i User Guide.

Getting Help

If you have any questions as you use your new CapTel phone, we're here to help. Use any of these ways to contact us:

Pick up the handset and press  (**CUSTOMER SERVICE button**) to automatically speed dial directly to our helpful Customer Service team. If you are in an office setting, you may need to dial a number such as "9" first to get an outside line first and then press  (**CUSTOMER SERVICE button**). *(Available 24 hours a day, 7 days a week. Customer Service is closed on major holidays.)*

Help materials are also available online at our website.



Phone: 1-888-269-7477 *(Available 24 hours a day, 7 days a week)*

FAX: (608) 238-3008



Mail: CapTel Customer Service
450 Science Drive
Madison, WI 53711



Email: CapTel@CapTel.com

Online: www.CapTel.com
(Live Chat help available at our website)

Spanish Language Customer Service: 1-866-670-9134